

GLOBE

FIRE SPRINKLER CORPORATION



RESIDENTIAL SPRINKLER INSTALLATION GUIDE

4077 AIR PARK DRIVE • STANDISH, MICHIGAN 48658
PHONE 989-846-4583 • 800-248-0278
FAX 989-846-9231
www.globesprinkler.com

GFS-380 (formerly A-15)

GLOBE RESIDENTIAL SPRINKLER GUIDE

DESCR., WARNING AND IMPORTANT NOTES	1-2
GL SERIES RESIDENTIAL SPR. DESIGN GUIDE	3-4
DISCHARGE TABLES	5
PENDENT WALL WETTING	6-11
CONCEALED PENDENT WALL WETTING	12-15
FLUSH PENDENT WALL WETTING	16
HORIZONTAL SIDEWALL WALL WETTING	17-22
INSTALLATION DIAGRAMS	23-28

GLOBE RESIDENTIAL SPRINKLER GUIDE

GENERAL DESCRIPTION

Globe Fire Sprinkler Corporation Model GL pendent and horizontal sidewall residential sprinklers are Listed by Underwriters Laboratories Inc. for use in wet pipe sprinkler systems conforming to the design/usage requirements of NFPA 13, NFPA 13D and NFPA 13R. These sprinklers have been specially designed to conform to these standards as a minimum and additionally to the Underwriters Laboratories Inc. Standard for Residential Sprinklers for Fire Protection Service, UL 1626. They are also approved for use by the New York City Department of Buildings. Because residential sprinklers are significantly faster in operation (fast response) than ordinary sprinklers, it is extremely important that they be used in accordance with their U.L. listing, the appropriate NFPA standards and the criteria set forth herein by Globe.

WARNINGS

1. Installation of Globe GL Series Residential Sprinklers shall conform to the installation requirements of NFPA 13, 13D or 13R. Other requirements may be stipulated by local codes or authority having jurisdiction.
2. The contractor is responsible to give the owner of the system, or his representative, a copy of this guide. Further, the owner should give a copy of this guide to a succeeding owner.
3. The owner is responsible for maintaining the system in proper working order.
4. Residential automatic sprinkler systems should be maintained and inspected in accordance with NFPA 13, 13D, 13R and 25 specifications. Professional maintenance is recommended.
5. Any questions regarding the installation of Globe GL Series Residential Sprinklers not answered in this guide may be directed to the Globe Fire Sprinkler Corporation and/or the National Fire Protection Association, as well as the authority having jurisdiction.
6. Unless specifically noted the specifications in this guide shall not take precedence over the requirements noted in item 1.
7. Areas such as hallways, stairwells, landings, dinettes and rooms must be separated by beams, lintels or soffits that are 8 or more inches in depth to be considered single compartments.
8. Only use the minimum number of sprinklers necessary for each compartment. Do NOT use more sprinklers than required per compartment.
9. Use only a maximum torque of 25 ft. lbs. to install Globe GL Series Residential Sprinklers. Use of higher torque levels may distort the seating area the sprinkler, resulting in leakage.
10. Do not hang anything from the sprinklers.
11. Do not put curtains, drapes or valences around sprinklers.
12. Do not use soap and water, detergents, cleaning agents, ammonia or other chemicals to clean sprinklers. To remove dust, cobwebs, lint, etc., carefully use a feather duster or vacuum with a soft brush attachment.

IMPORTANT NOTES

1. Residential Fire Sprinkler Systems should only be designed and installed by competent professionals having full knowledge of the special design/usage requirements involved. Any changes necessary to an existing approved system should only be performed by such competent professional individuals.
2. Should the original water supply used to design the approved installed system change, it is most important that its effect on the sprinkler system be reviewed by competent professionals familiar with these special fire protection systems.
3. More information concerning Globe's GL Series Residential Sprinklers may be obtained upon request to the Globe "Customer Service Department" at the address contained in this document.

GLOBE RESIDENTIAL SPRINKLER GUIDE

NFPA 13 REQUIREMENTS:

When sprinklers are used in NFPA 13 Systems, A 0.1 Design Density minimum shall be utilized.

NFPA 13D REQUIREMENTS:

For each of the following situations, the number of sprinklers in the design area shall be all of the sprinklers within a compartment, up to a maximum of two sprinklers, that require the greatest hydraulic demand.

- (1). A flat smooth, horizontal ceiling with no beams up to a maximum of 24 ft. above the floor.
- (2). A flat, horizontal beamed ceiling with a maximum ceiling height of 24 ft., with beams up to 14in. deep with pendent sprinklers under the beams. The compartment containing the beamed ceiling shall be a maximum of 600 ft² in area. The highest sprinkler in the compartment shall be above all openings from the compartment into any communicating spaces.
- (3). A smooth flat sloped ceiling with no beams up to a maximum slope of 8 in 12. The highest portion of the ceiling shall not be more than 24 ft. above the floor. The highest sprinkler in the sloped portion of the ceiling shall be above all openings from the compartment containing the sloped ceiling into any communicating spaces.
- (4). A sloped ceiling with beams up to 14 in. deep with pendent sprinklers under the beams. The compartment containing the sloped beamed ceiling shall be a maximum of 600 ft² in area. The slope of the ceiling shall be between 2 in 12 and 8 in 12. The highest portion of the ceiling shall not be more than 24 ft. above the floor. The highest sprinkler in the sloped portion of the ceiling shall be above all openings from the compartment containing the sloped ceiling into any communicating spaces.
- (5). A sloped ceiling with beams of any depth with sidewall or pendent sprinklers in each pocket formed by the beams. The compartment containing the sloped, beamed ceiling shall be a maximum of 600 ft² in area. The slope of the ceiling shall be between 2 in 12 and 8 in 12. The highest portion of the ceiling shall not be more than 24 ft. above the floor.

For situations not meeting one of the conditions above, residential sprinklers listed for use in specific ceiling configurations shall be permitted to be used in accordance with their listings.

For situations not meeting one of the conditions above, the number of sprinklers in the design area shall be determined in consultation with the authority having jurisdiction as appropriate for the conditions. Sprinklers shall be installed in accordance with their listing where a type of ceiling configuration is referenced in the listing.

NFPA 13R REQUIREMENTS:

Horizontal Ceiling criteria may be used for sloped ceiling configurations up to 8:12 pitch when acceptable to the Local Authority having Jurisdiction.

The following pages contain illustrations for customers reference. If conflicting data is found, NFPA 13, 13D, or 13R requirements take precedence.

GLOBE RESIDENTIAL SPRINKLER GUIDE

GL SERIES RESIDENTIAL SPRINKLER DESIGN GUIDE

STYLE	SIN MODEL	K FACTOR	TEMP. °F	COVERAGE FT x FT	MINIMUM FLOW GPM *	MINIMUM PRESSURE PSI *
PENDENT & RECESSED	GL4110	4.1	155, 175	12 x 12	11	7.2
				14 x 14	12	8.6
				16 x 16	14	11.7
PENDENT & RECESSED	GL4910	4.9	155, 175	12 x 12	13	7
				14 x 14	14	8.2
				16 x 16	14	8.2
				18 x 18	17	12
				20 x 20	20	16.7
ADJUSTABLE CONCEALED PENDENT	GL4147	4.1	155	12 x 12	11	7.2
				14 x 14	15	13.4
				16 x 16	15	13.4
ADJUSTABLE CONCEALED PENDENT	GL4947	4.9	155	12 x 12	13	7.7
				14 x 14	14	8.2
				16 x 16	14	8.2
				18 x 18	17	12
				20 x 20	20	16.7
ONE INCH ADJUSTABLE CONCEALED PENDENT	GL4906	4.9	155	12 x 12	13	7
				14 x 14	13	7
				16 x 16	13	7
				18 x 18	17	12
				20 x 20	20	16.7
HORIZONTAL SIDEWALL & RECESSED	GL4231	4.2	155, 175	12 x 12	13	9.6
				14 x 14	15	12.8
				16 x 16	16	14.5
				16 x 18	19	20.5
				16 x 20	23	30
HORIZONTAL SIDEWALL & RECESSED	GL4431	4.4	155, 175	12 x 12	13	8.7
				14 x 14	15	11.6
				16 x 16	16	13.2
				16 x 18	19	18.7
				16 x 20	23	27.3
PENDENT & RECESSED	GL5610	5.6	155	12 x 12	15	7.2
				14 x 14	19	11.5
				16 x 16	19	11.5
				18 x 18	21	14.1
				20 x 20	24	18.4
PENDENT & RECESSED	GL3010	3	155	12 x 12	8	7.1
				14 x 14	10	11.1
FLUSH PENDENT	GL4248	4.1	155	12 x 12	11	7.2
				14 x 14	11	7.2
				16 x 16	13	10
				18 x 18	17	17.2
				20 x 20	20	23.8

*WHEN THESE SPRINKLERS ARE USED IN NFPA 13 SYSTEMS, A 0.1 DESIGN DENSITY MINIMUM SHALL BE UTILIZED.

GLOBE RESIDENTIAL SPRINKLER GUIDE

GL SERIES RESIDENTIAL SPRINKLER DESIGN GUIDE

STYLE	SIN MODEL	K FACTOR	TEMP. °F	COVERAGE FT x FT	MINIMUM FLOW GPM **	MINIMUM PRESSURE PSI **
REPLACEMENT PENDENT & RECESSED (RES3)	GL2810	2.8	155, 175	12 x 12	10	12.7
				14 x 14	10	12.7
				16 x 16	11	15.4
				18 x 18	13	21.6
				20 x 20	16	32.7
REPLACEMENT PENDENT	GL4210	4.2	155	14 x 14	20	22.7
				16 x 16	20	22.7
REPLACEMENT RECESSED PENDENT	GL4210	4.2	155	14 x 14	18	18.4
				16 x 16	18	18.4
				18 x 18	18	18.4
REPLACEMENT PENDENT & RECESSED	GL4210	4.2	155	12 x 12	13	9.6
				20 x 20	19	20.5
REPLACEMENT CONCEALED PENDENT or REPLACEMENT ADJUSTABLE CONCEALED PENDENT	GL3511 or GL3547	3.5	155	12 x 12	9	7
				14 x 14	12	11.7
				16 x 16	12	11.7
				18 x 18	16	13.8
REPLACEMENT CONCEALED PENDENT or REPLACEMENT ADJUSTABLE CONCEALED PENDENT	GL4211 or GL4247	4.2	155	20 x 20	16	20.9
				12 x 12	13	9.6
				14 x 14	17	16.4
REPLACEMENT HORIZONTAL SIDEWALL & RECESSED (RES4)	GL4234	4.2	155, 175	16 x 16	22	27.4
				12 x 12	13	9.6
					*15	12.8
				14 x 14	14	11.1
					*16	14.5
				16 x 16	17	16.4
					*19	20.5
REPLACEMENT HORIZONTAL SIDEWALL & RECESSED (RES)	GL4230	4.2	155	16 x 18	21	25.0
				16 x 20	27	41.3
				18 x 18	22	27.4
REPLACEMENT HORIZONTAL SIDEWALL & RECESSED (RES)	GL5630	5.6	155	12 x 12	19	20.5
				14 x 14	21	25.0
				16 x 16	24	32.7
REPLACEMENT HORIZONTAL SIDEWALL & RECESSED (RES)	GL5631	5.6	155	12 x 12	20	12.8
				14 x 14	23	16.9
				16 x 16	24	18.4
REPLACEMENT HORIZONTAL SIDEWALL & RECESSED (RES2)	GL5631	5.6	155	12 x 12	18	10.3
				16 x 18	30	28.7
				16 x 20	35	39.1

*DEFLECTOR POSITION BELOW CEILING 6" TO 12".

**WHEN THESE SPRINKLERS ARE USED IN NFPA 13 SYSTEMS, A 0.1 DESIGN DENSITY MINIMUM SHALL BE UTILIZED.

GLOBE WALL WETTING PATTERNS

MODELS GL4110 & GL4910 RESIDENTIAL

PENDENT AND RECESSED PENDENT SPRINKLERS

MODEL GL4110 - K = 4.1 (58 metric) & MODEL GL4910 - K = 4.9 (68 metric)

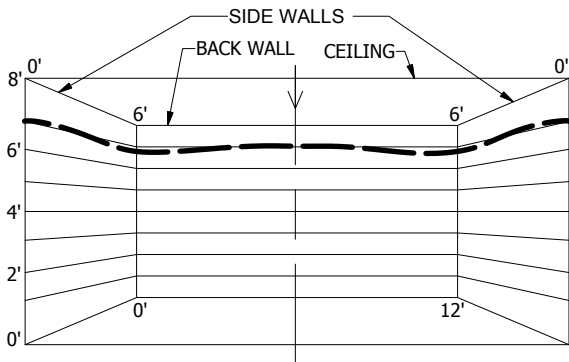

GL4110 - 11 GPM - 7.2 PSI
 GL4910 - 13 GPM - 7 PSI
 12' x 12' ROOM SIZE
 (HALF PATTERN)

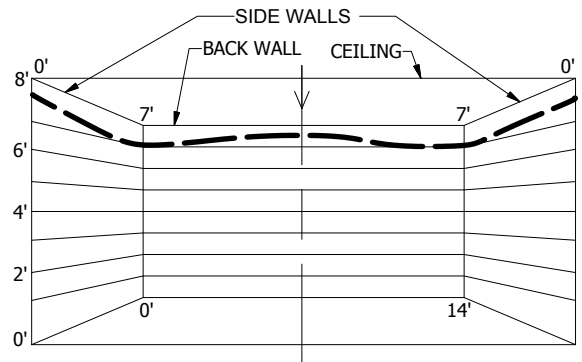

GL4110 - 12 GPM - 8.6 PSI
 GL4910 - 14 GPM - 8.2 PSI
 14' x 14' ROOM SIZE
 (HALF PATTERN)

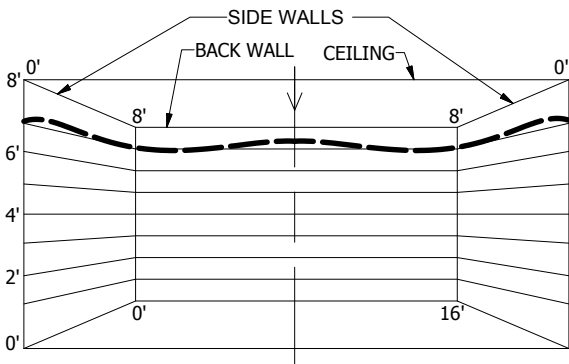

GL4110 - 14 GPM - 11.7 PSI
 GL4910 - 14 GPM - 8.2 PSI
 16' x 16' ROOM SIZE
 (HALF PATTERN)

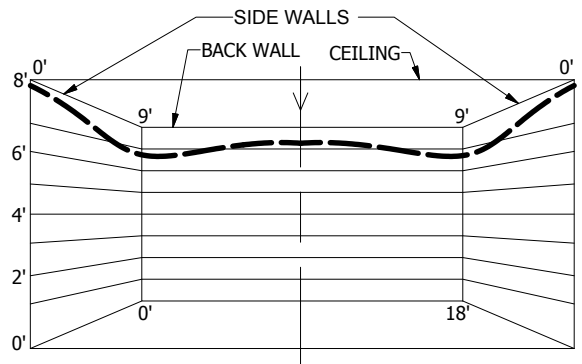

GL4910 - 18 GPM - 13.5 PSI
 18' x 18' ROOM SIZE
 (HALF PATTERN)

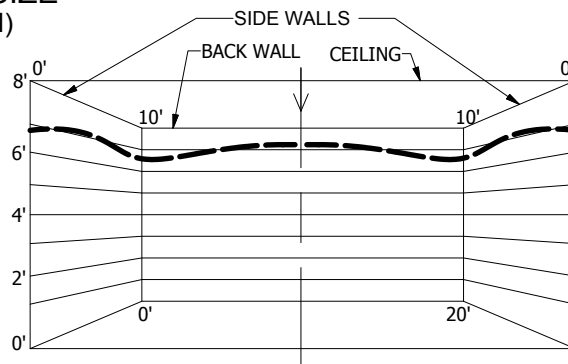

GL4910 - 20 GPM - 16.7 PSI
 20' x 20' ROOM SIZE
 (HALF PATTERN)

FLOW LEGEND

■ ■ ■ TOP OF SPRINKLER FLOW

GLOBE WALL WETTING PATTERNS

MODEL GL3010 RESIDENTIAL PENDENT AND RECESSED PENDENT SPRINKLER MODEL GL3010 - K = 3.0 (42 metric)

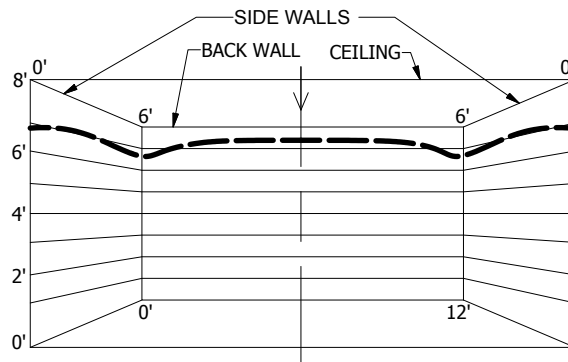

GL3010 - 8 GPM - 7.1 PSI
12' x 12' ROOM SIZE
(HALF PATTERN)

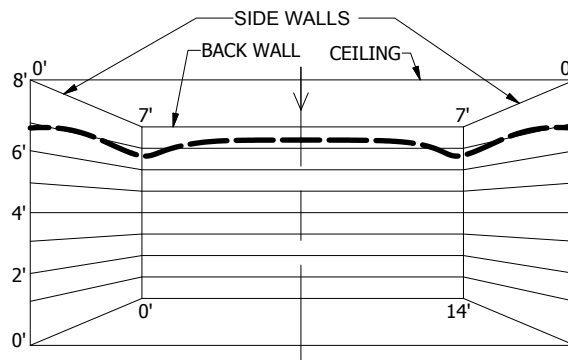

GL3010 - 10 GPM - 11.1 PSI
14' x 14' ROOM SIZE
(HALF PATTERN)

FLOW LEGEND

■ ■ ■ TOP OF SPRINKLER FLOW

GLOBE WALL WETTING PATTERNS

MODEL GL5610 RESIDENTIAL PENDENT AND RECESSED PENDENT SPRINKLERS MODEL GL5610 - K = 5.6 (80 metric)

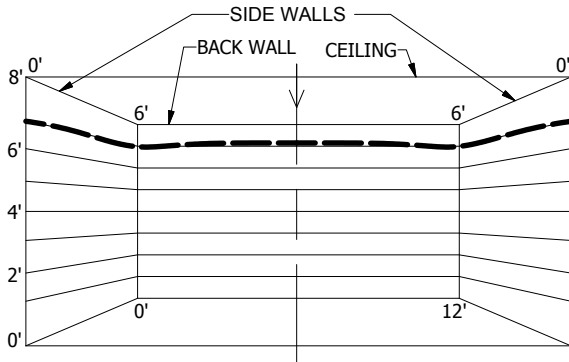

GL5610 - 15 GPM - 7.2 PSI
12' x 12' ROOM SIZE
(HALF PATTERN)

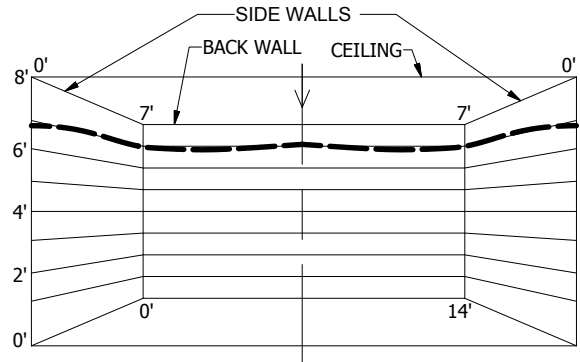

GL5610 - 19 GPM - 11.5 PSI
14' x 14' ROOM SIZE
(HALF PATTERN)

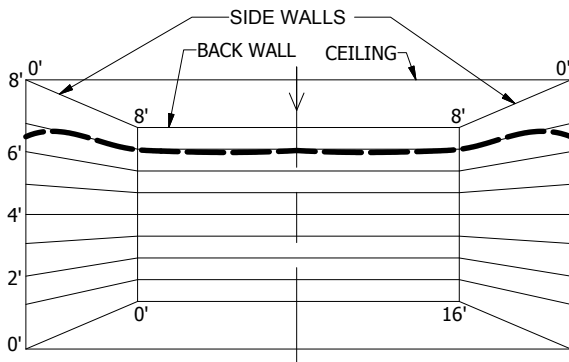

GL5610 - 19 GPM - 11.5 PSI
16' x 16' ROOM SIZE
(HALF PATTERN)

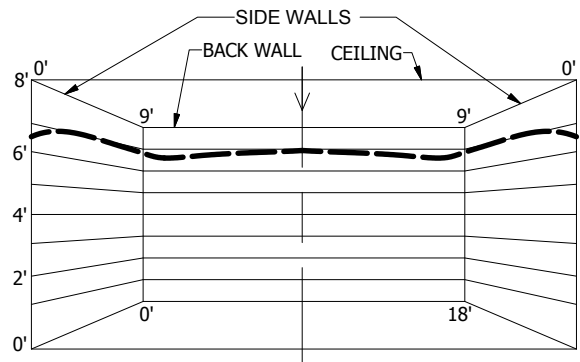

GL5610 - 21 GPM - 14.1 PSI
18' x 18' ROOM SIZE
(HALF PATTERN)

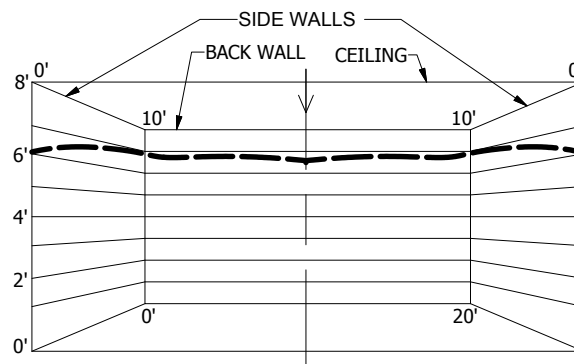

GL5610 - 24 GPM - 18.4 PSI
20' x 20' ROOM SIZE
(HALF PATTERN)

FLOW LEGEND

--- TOP OF SPRINKLER FLOW

GLOBE WALL WETTING PATTERNS

MODEL GL2810 REPLACEMENT RESIDENTIAL PENDENT AND RECESSED PENDENT SPRINKLERS MODEL GL2810 - K = 2.8 (39 metric)

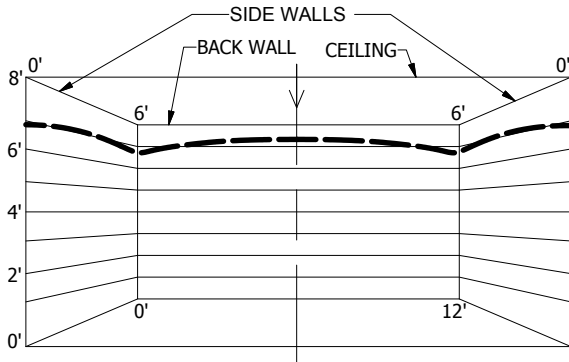

GL2810 - 10 GPM - 12.7 PSI
12' x 12' ROOM SIZE
(HALF PATTERN)

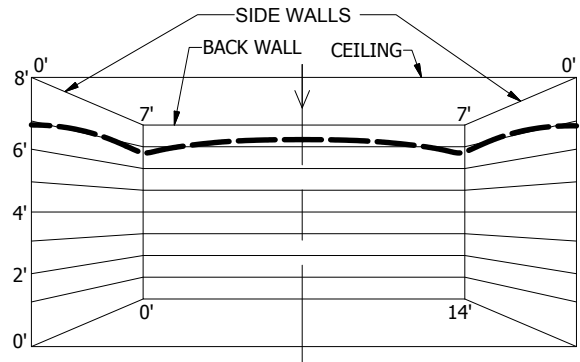

GL2810 - 10 GPM - 12.7 PSI
14' x 14' ROOM SIZE
(HALF PATTERN)

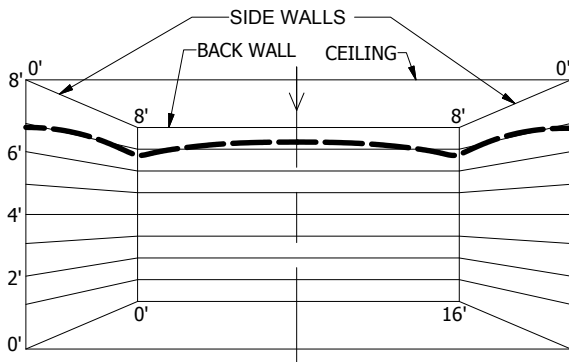

GL2810 - 10 GPM - 12.7 PSI
16' x 16' ROOM SIZE
(HALF PATTERN)

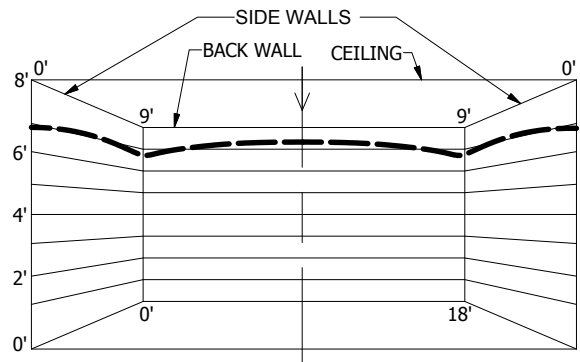

GL2810 - 11 GPM - 15.4 PSI
18' x 18' ROOM SIZE
(HALF PATTERN)

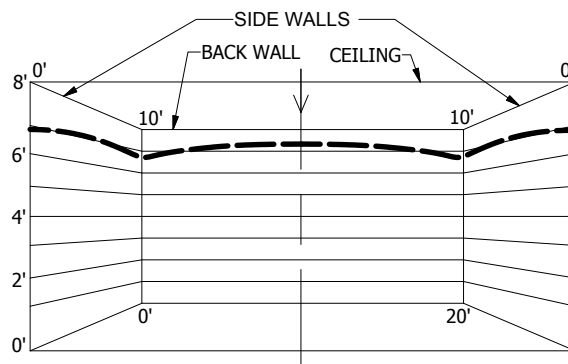

GL2810 - 14 GPM - 25.0 PSI
20' x 20' ROOM SIZE
(HALF PATTERN)

FLOW LEGEND

--- TOP OF SPRINKLER FLOW

GLOBE WALL WETTING PATTERNS

MODEL GL4210 REPLACEMENT RESIDENTIAL PENDENT AND RECESSED PENDENT SPRINKLERS

MODEL GL4210 - K = 4.2 (59 metric)

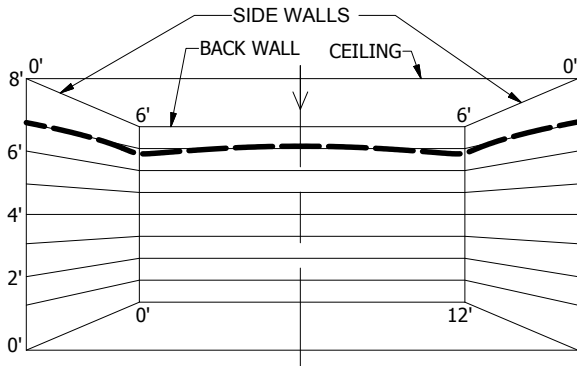

GL4210 - 13 GPM - 9.6 PSI
PENDENT STYLE

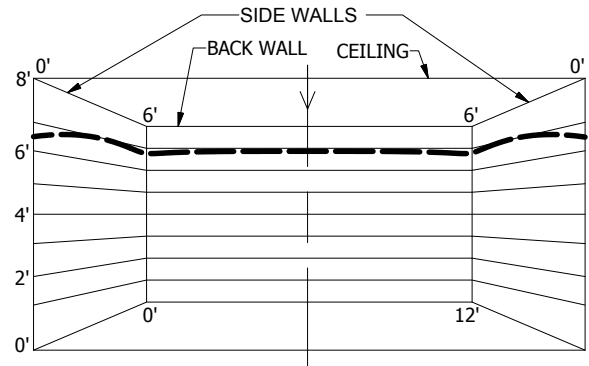

GL4210 - 13 GPM - 9.6 PSI
RECESSED PENDENT STYLE

12' x 12' ROOM SIZE
(HALF PATTERN)

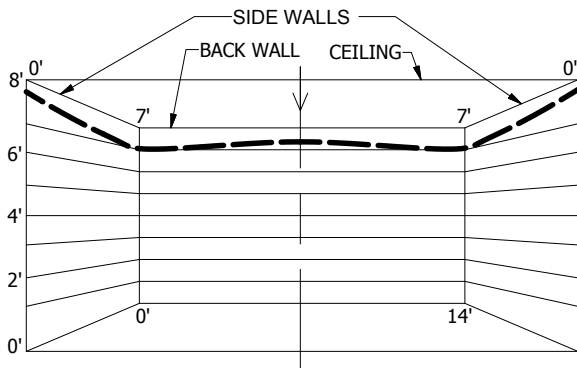

GL4210 - 20 GPM - 22.7 PSI
PENDENT STYLE

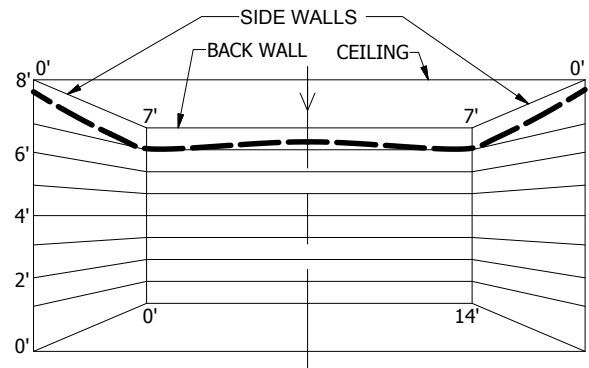

GL4210 - 18 GPM - 18.4 PSI
RECESSED PENDENT STYLE

14' x 14' ROOM SIZE
(HALF PATTERN)

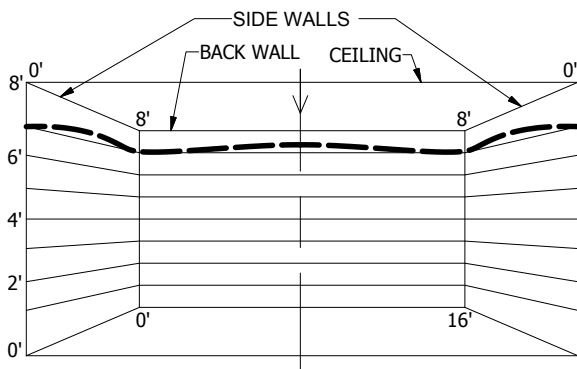

GL4210 - 20 GPM - 22.7 PSI
PENDENT STYLE

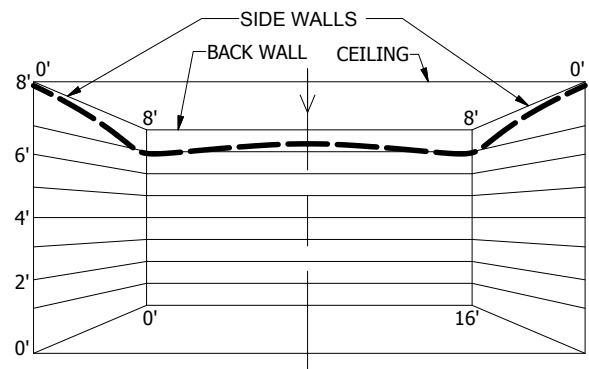

GL4210 - 18 GPM - 18.4 PSI
RECESSED PENDENT STYLE

16' x 16' ROOM SIZE
(HALF PATTERN)

FLOW LEGEND

--- TOP OF SPRINKLER FLOW

GLOBE WALL WETTING PATTERNS

MODEL GL4210 REPLACEMENT RESIDENTIAL PENDENT AND RECESSED PENDENT SPRINKLERS MODEL GL4210 - K = 4.2 (59 metric)

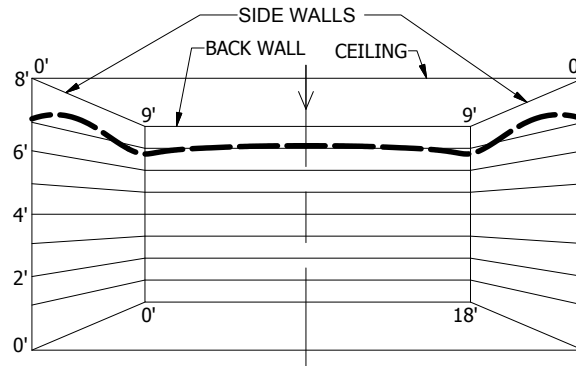

GL4210 - 18 GPM - 18.4 PSI
RECESSED PENDENT STYLE

18' x 18' ROOM SIZE
(HALF PATTERN)

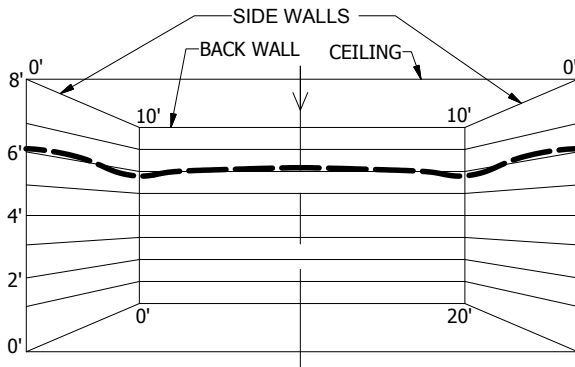

GL4210 - 19 GPM - 20.5 PSI
PENDENT STYLE

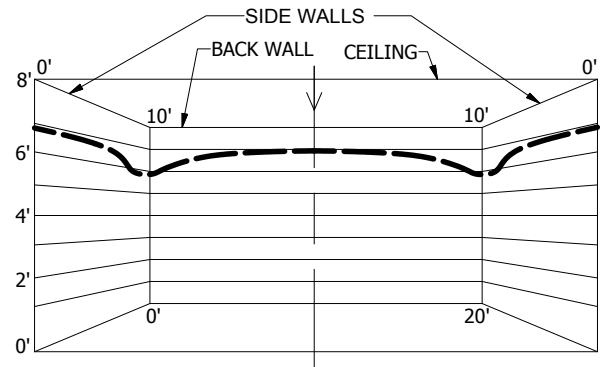

GL4210 - 19 GPM - 20.5 PSI
RECESSED PENDENT STYLE

20' x 20' ROOM SIZE
(HALF PATTERN)

FLOW LEGEND

■ ■ ■ TOP OF SPRINKLER FLOW

GLOBE WALL WETTING PATTERNS

MODEL GL4147 RESIDENTIAL CONCEALED PENDENT SPRINKLER MODEL GL4147 - K = 4.1 (58 metric)

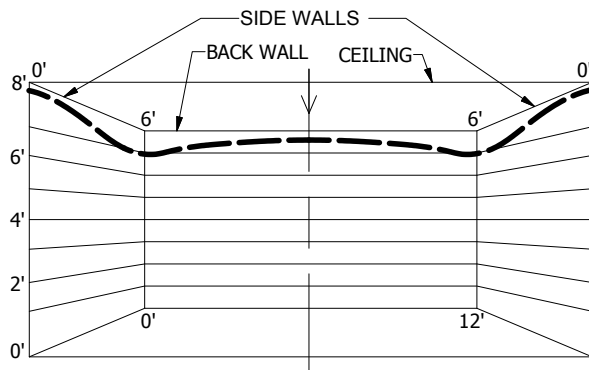

GL4147 - 11 GPM - 7.2 PSI
12' x 12' ROOM SIZE
(HALF PATTERN)

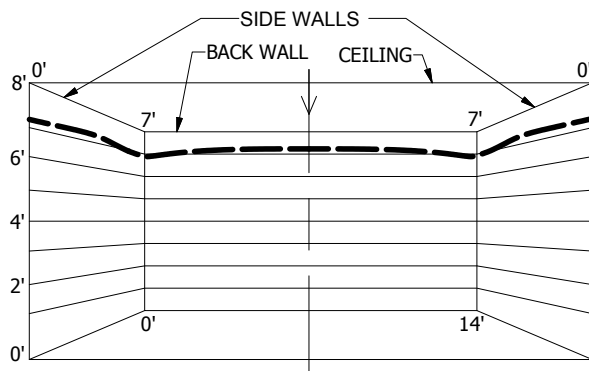

GL4147 - 15 GPM - 13.4 PSI
14' x 14' ROOM SIZE
(HALF PATTERN)

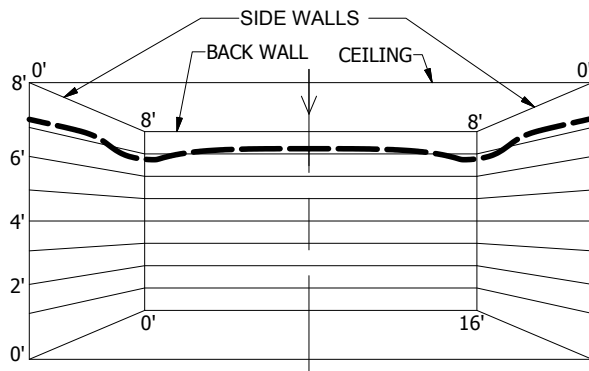

GL4147 - 15 GPM - 13.4 PSI
16' x 16' ROOM SIZE
(HALF PATTERN)

FLOW LEGEND

■■■■ TOP OF SPRINKLER FLOW

GLOBE WALL WETTING PATTERNS

MODELS GL4947 & GL4906 RESIDENTIAL ADJUSTABLE CONCEALED PENDENT SPRINKLERS

MODEL GL4947 & GL4906 - K = 4.9 (68 metric)

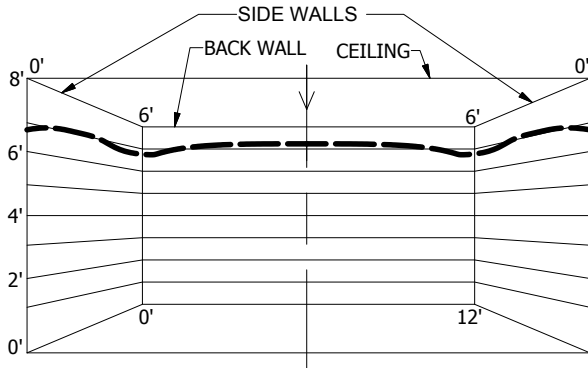

GL4947 - 13 GPM - 7 PSI
GL4906 - 13 GPM - 7 PSI
12' x 12' ROOM SIZE
(HALF PATTERN)

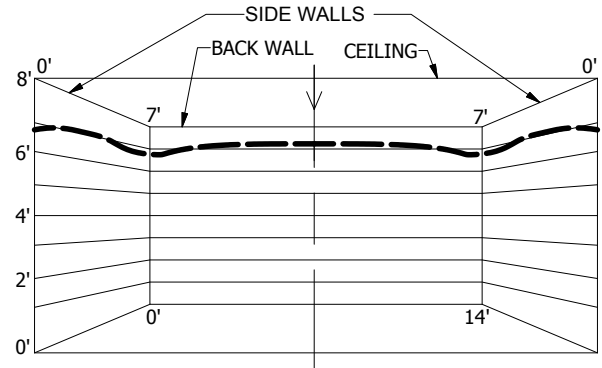

GL4947 - 14 GPM - 8.2 PSI
GL4906 - 13 GPM - 7 PSI
14' x 14' ROOM SIZE
(HALF PATTERN)

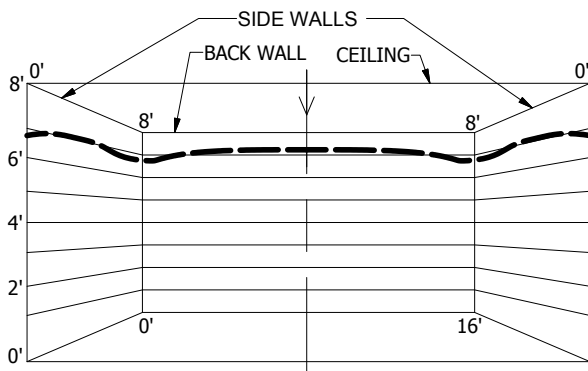

GL4947 - 14 GPM - 8.2 PSI
GL4906 - 13 GPM - 7 PSI
16' x 16' ROOM SIZE
(HALF PATTERN)

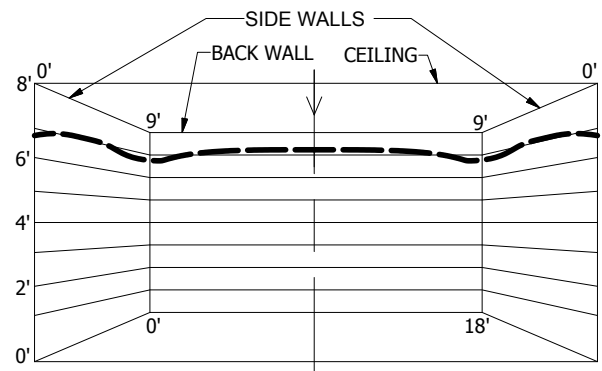

GL4947 - 17 GPM - 12 PSI
GL4906 - 17 GPM - 12 PSI
18' x 18' ROOM SIZE
(HALF PATTERN)

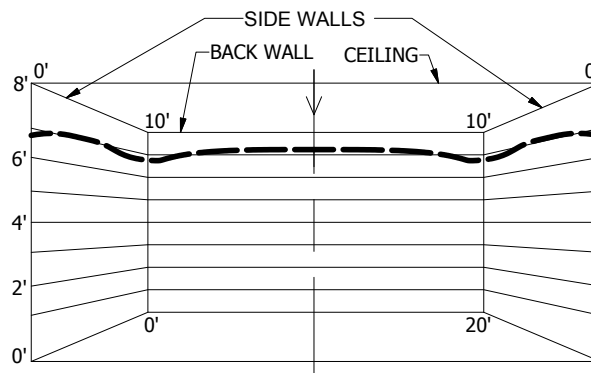

GL4947 - 20 GPM - 16.7 PSI
GL4906 - 20 GPM - 16.7 PSI
20' x 20' ROOM SIZE
(HALF PATTERN)

FLOW LEGEND

■■■■ TOP OF SPRINKLER FLOW

GLOBE WALL WETTING PATTERNS

MODEL GL4211 REPLACEMENT RESIDENTIAL CONCEALED PENDENT SPRINKLERS MODEL GL4211 - K = 4.2 (59 metric)

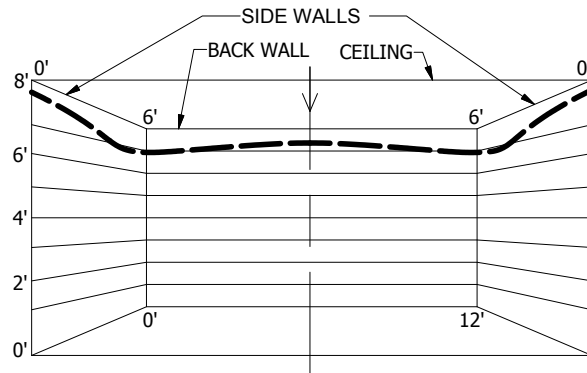

GL4211 - 13 GPM - 9.6 PSI
12' x 12' ROOM SIZE
(HALF PATTERN)

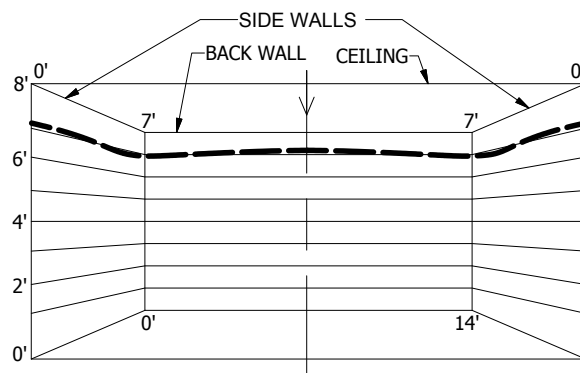

GL4211 - 17 GPM - 16.4 PSI
14' x 14' ROOM SIZE
(HALF PATTERN)

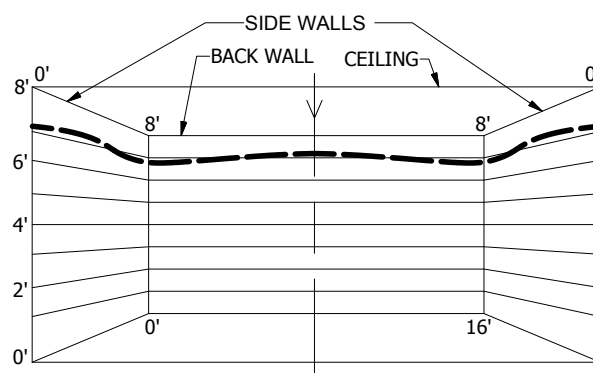

GL4211 - 22 GPM - 27.4 PSI
16' x 16' ROOM SIZE
(HALF PATTERN)

FLOW LEGEND

■■■■ TOP OF SPRINKLER FLOW

GLOBE WALL WETTING PATTERNS

MODELS GL3511 & GL3547 REPLACEMENT RESIDENTIAL CONCEALED PENDENT SPRINKLERS

MODEL GL3511 & GL3547 - K = 3.5 (49 metric)

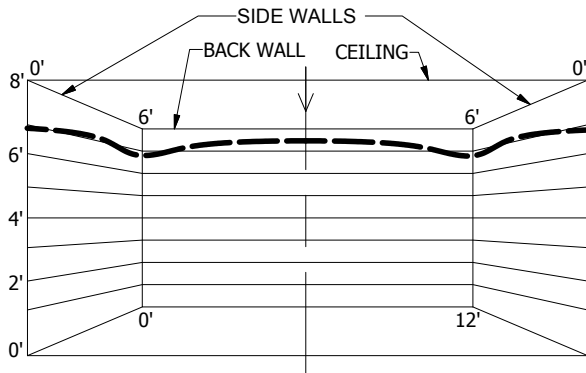

GL3511 & GL3547 - 11 GPM - 7.2 PSI
12' x 12' ROOM SIZE
(HALF PATTERN)

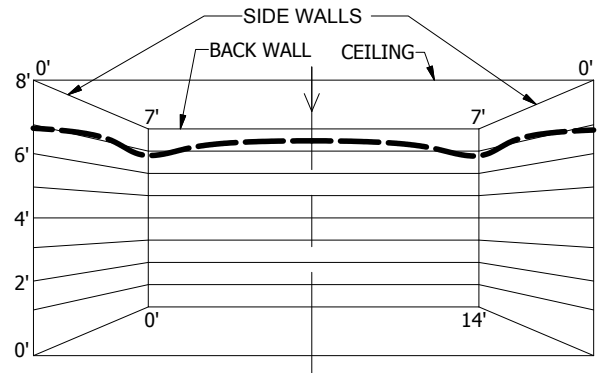

GL3511 & GL3547 - 11 GPM - 7.2 PSI
14' x 14' ROOM SIZE
(HALF PATTERN)

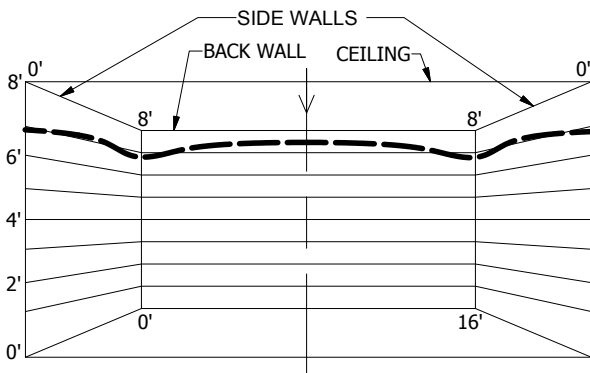

GL3511 & GL3547 - 13 GPM - 10 PSI
16' x 16' ROOM SIZE
(HALF PATTERN)

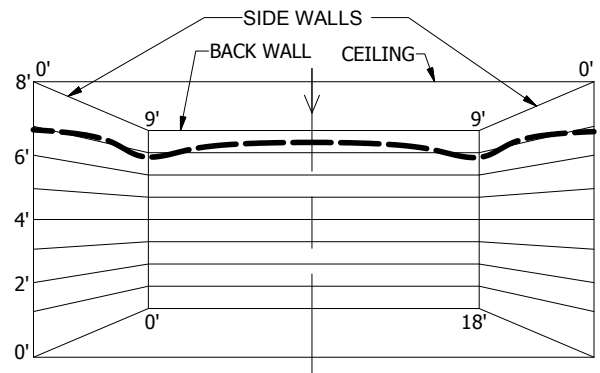

GL3511 & GL3547 - 17 GPM - 17.2 PSI
18' x 18' ROOM SIZE
(HALF PATTERN)

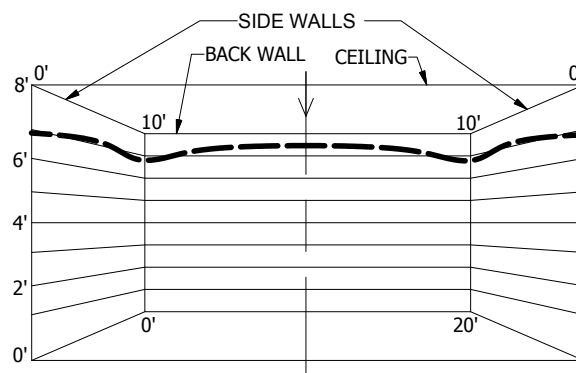

GL3511 & GL3547 - 20 GPM - 23.8 PSI
20' x 20' ROOM SIZE
(HALF PATTERN)

FLOW LEGEND

--- TOP OF SPRINKLER FLOW

GLOBE WALL WETTING PATTERNS

MILLENNIUM™ MODEL GL4248 RESIDENTIAL FLUSH PENDENT SPRINKLERS MODEL GL4248 - K = 4.1 (58 metric)

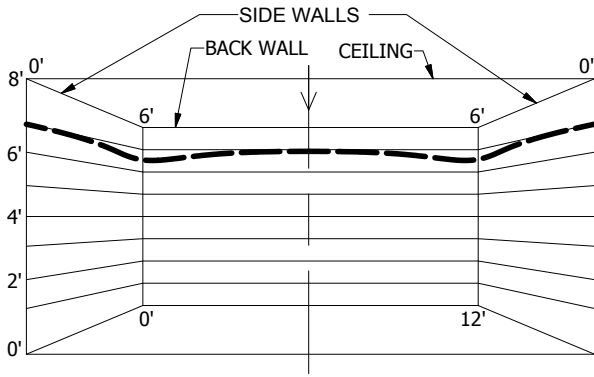

GL4248 - 11 GPM - 7.2 PSI
12' x 12' ROOM SIZE
(HALF PATTERN)

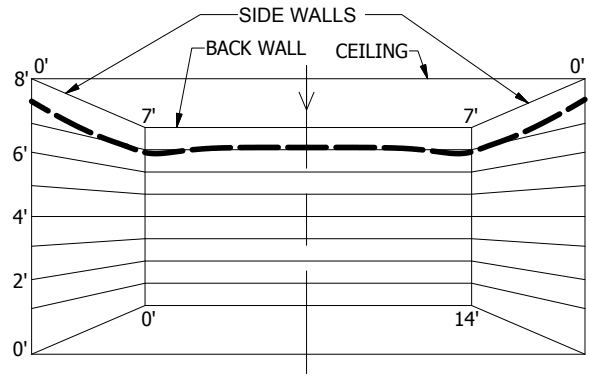

GL4248 - 11 GPM - 7.2 PSI
14' x 14' ROOM SIZE
(HALF PATTERN)

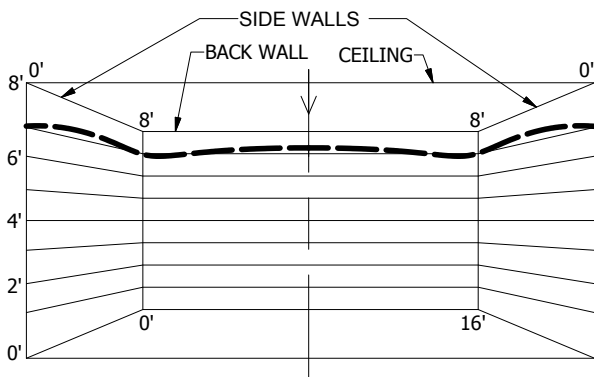

GL4248 - 13 GPM - 10 PSI
16' x 16' ROOM SIZE
(HALF PATTERN)

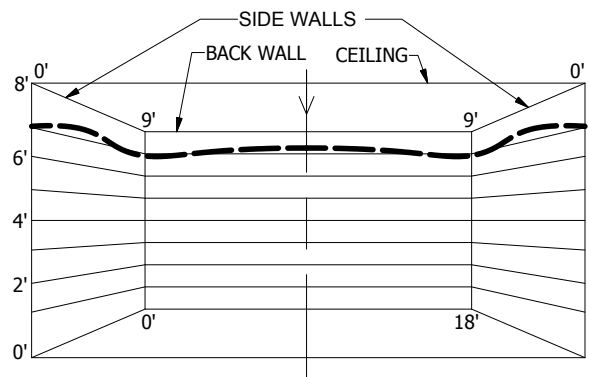

GL4248 - 17 GPM - 17.2 PSI
18' x 18' ROOM SIZE
(HALF PATTERN)

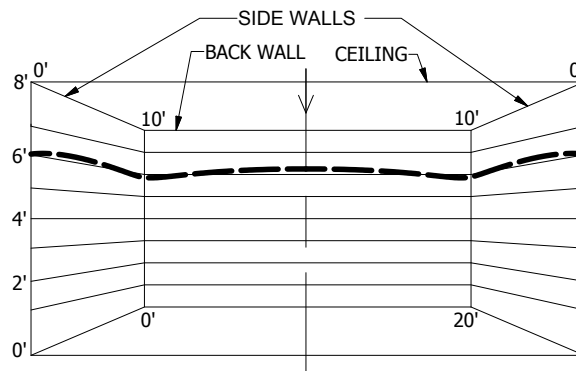

GL4248 - 20 GPM - 23.8 PSI
20' x 20' ROOM SIZE
(HALF PATTERN)

FLOW LEGEND

■■■■ TOP OF SPRINKLER FLOW

GLOBE WALL WETTING PATTERNS

MODEL GL4231 RESIDENTIAL HORIZONTAL SIDEWALL AND RECESSED HORIZONTAL SIDEWALL SPRINKLERS

MODEL GL4231 - K = 4.2 (59 metric)

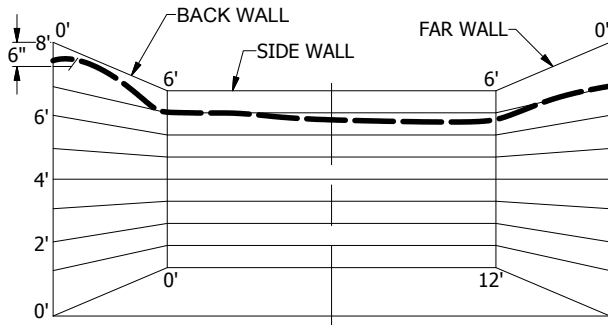

GL4231 - 13 GPM - 9.6 PSI
DEFLECTOR 6" BELOW CEILING
12' x 12' ROOM SIZE
(HALF PATTERN)

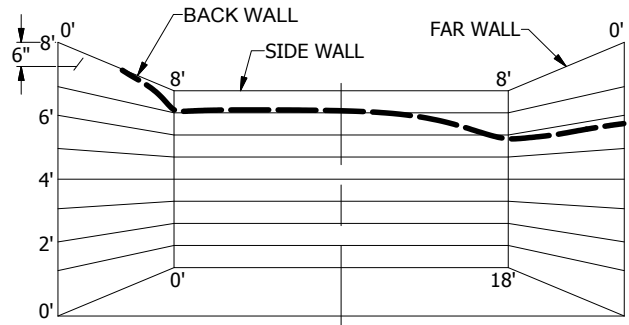

GL4231 - 19 GPM - 20.5 PSI
DEFLECTOR 6" BELOW CEILING
16' x 18' ROOM SIZE
(HALF PATTERN)

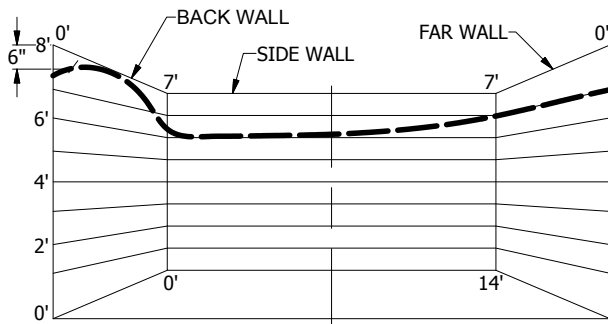

GL4231 - 15 GPM - 12.8 PSI
DEFLECTOR 6" BELOW CEILING
14' x 14' ROOM SIZE
(HALF PATTERN)

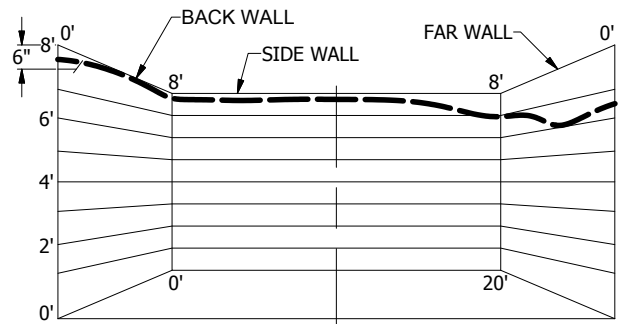

GL4231 - 23 GPM - 30.0 PSI
DEFLECTOR 6" BELOW CEILING
16' x 20' ROOM SIZE
(HALF PATTERN)

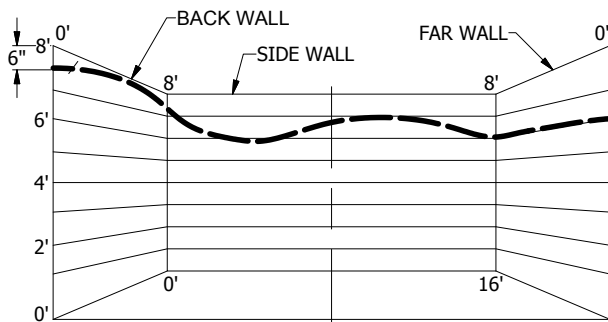

GL4231 - 16 GPM - 14.5 PSI
DEFLECTOR 6" BELOW CEILING
16' x 16' ROOM SIZE
(HALF PATTERN)

FLOW LEGEND

--- TOP OF SPRINKLER FLOW

GLOBE WALL WETTING PATTERNS

MODEL GL4431 RESIDENTIAL HORIZONTAL SIDEWALL AND RECESSED HORIZONTAL SIDEWALL SPRINKLERS

MODEL GL4431 - K = 4.4 (62 metric)

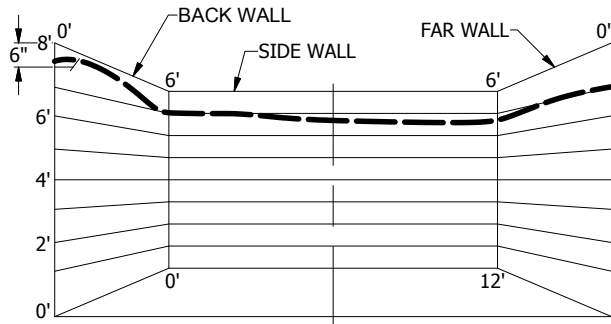

GL4431 - 13 GPM - 8.7 PSI
DEFLECTOR 6" BELOW CEILING
12' x 12' ROOM SIZE
(HALF PATTERN)

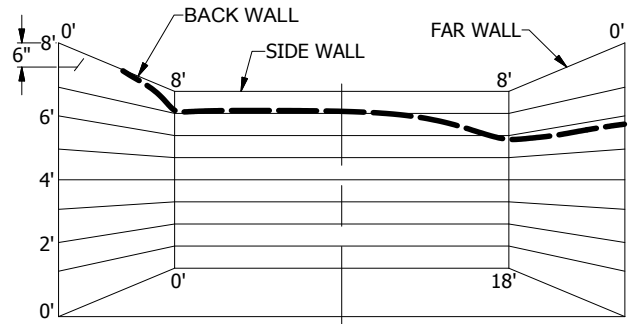

GL4431 - 19 GPM - 18.7 PSI
DEFLECTOR 6" BELOW CEILING
16' x 18' ROOM SIZE
(HALF PATTERN)

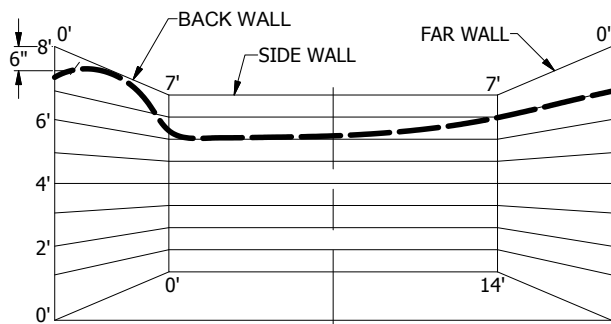

GL4431 - 15 GPM - 11.6 PSI
DEFLECTOR 6" BELOW CEILING
14' x 14' ROOM SIZE
(HALF PATTERN)

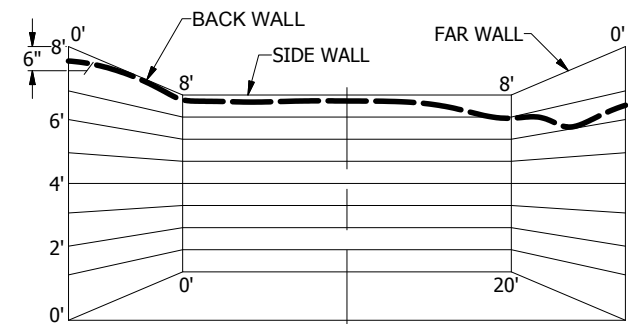

GL4431 - 23 GPM - 27.3 PSI
DEFLECTOR 6" BELOW CEILING
16' x 20' ROOM SIZE
(HALF PATTERN)

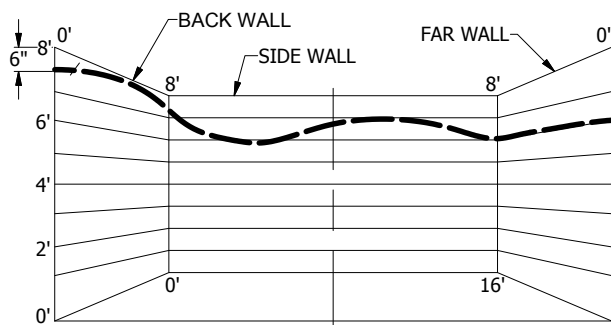

GL4431 - 16 GPM - 13.2 PSI
DEFLECTOR 6" BELOW CEILING
16' x 16' ROOM SIZE
(HALF PATTERN)

FLOW LEGEND

--- TOP OF SPRINKLER FLOW

GLOBE WALL WETTING PATTERNS

MODEL GL4234 REPLACEMENT RESIDENTIAL HORIZONTAL SIDEWALL AND RECESSED HORIZONTAL SIDEWALL SPRINKLERS MODEL GL4234 - K = 4.2 (59 metric)

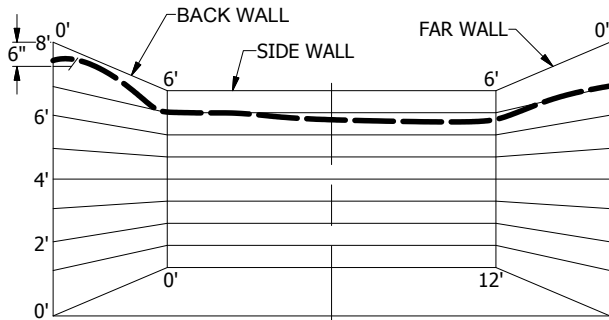

GL4234 - 13 GPM - 9.6 PSI
DEFLECTOR 6" BELOW CEILING

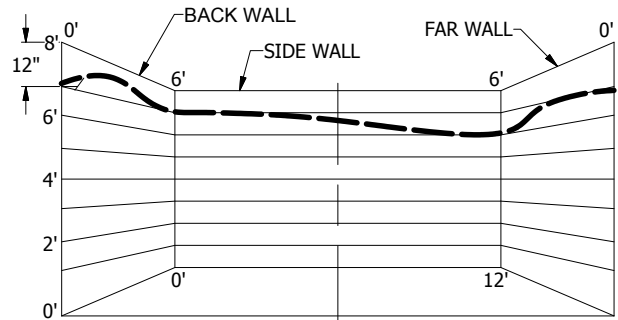

GL4234 - 15 GPM - 12.8 PSI
DEFLECTOR 12" BELOW CEILING

12' x 12' ROOM SIZE
(HALF PATTERN)

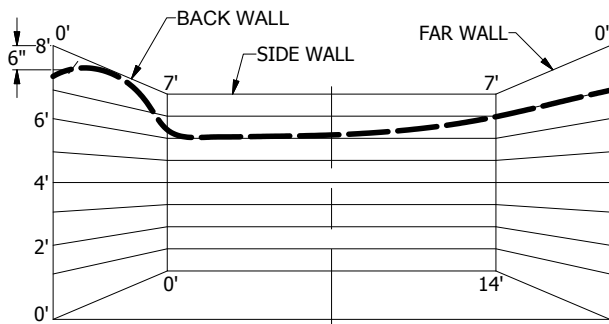

GL4234 - 14 GPM - 11.1 PSI
DEFLECTOR 6" BELOW CEILING

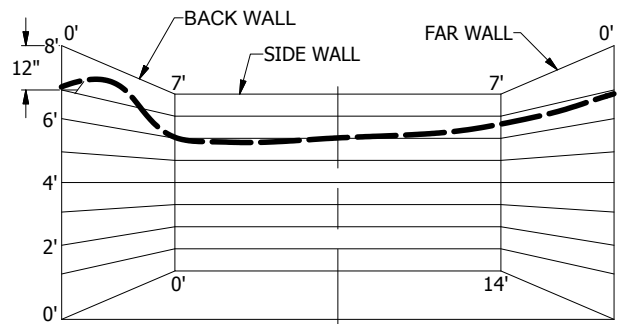

GL4234 - 16 GPM - 14.5 PSI
DEFLECTOR 12" BELOW CEILING

14' x 14' ROOM SIZE
(HALF PATTERN)

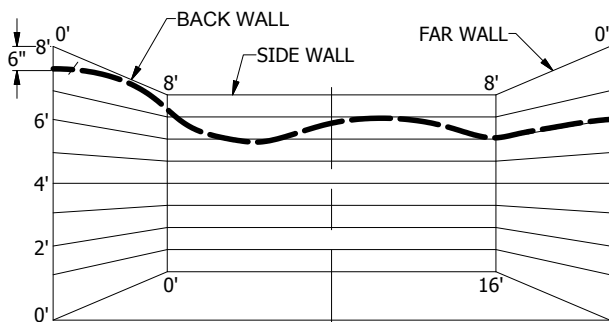

GL4234 - 17 GPM - 16.4 PSI
DEFLECTOR 6" BELOW CEILING

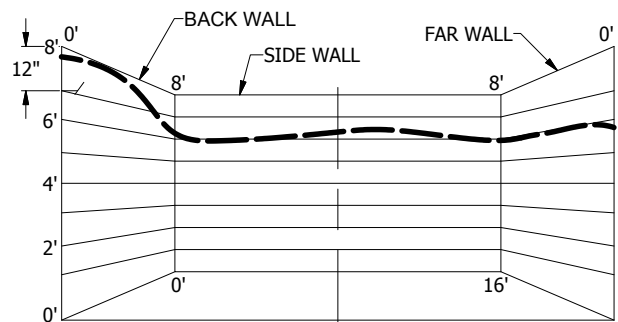

GL4234 - 19 GPM - 20.5 PSI
DEFLECTOR 12" BELOW CEILING

16' x 16' ROOM SIZE
(HALF PATTERN)

FLOW LEGEND

--- TOP OF SPRINKLER FLOW

GLOBE WALL WETTING PATTERNS

MODEL GL4234 REPLACEMENT RESIDENTIAL HORIZONTAL SIDEWALL AND RECESSED HORIZONTAL SIDEWALL SPRINKLERS MODEL GL4234 - K = 4.2 (59 metric)

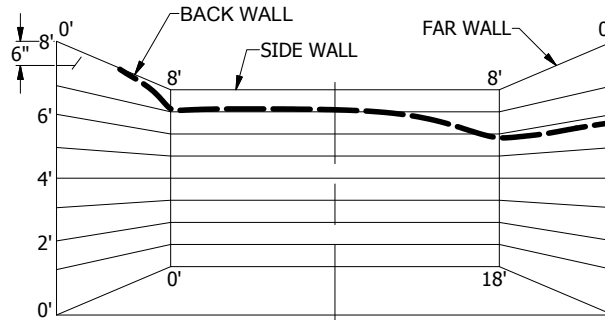

GL4234 - 21 GPM - 25.0 PSI
DEFLECTOR 6" BELOW CEILING
16' x 18' ROOM SIZE
(HALF PATTERN)

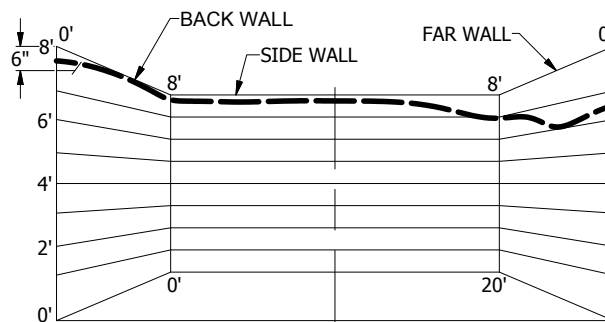

GL4234 - 27 GPM - 41.3 PSI
DEFLECTOR 6" BELOW CEILING
16' x 20' ROOM SIZE
(HALF PATTERN)

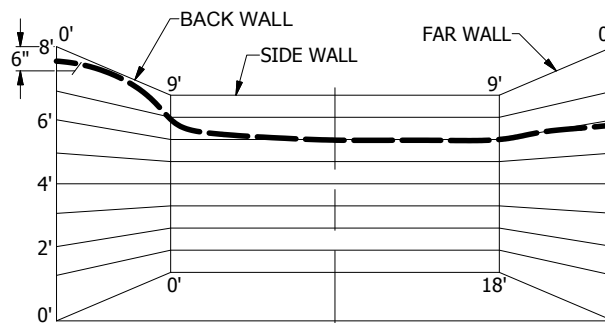

GL4234 - 22 GPM - 27.4 PSI
DEFLECTOR 6" BELOW CEILING
18' x 18' ROOM SIZE
(HALF PATTERN)

FLOW LEGEND

••••• TOP OF SPRINKLER FLOW

GLOBE WALL WETTING PATTERNS

GL SERIES REPLACEMENT RESIDENTIAL HORIZONTAL SIDEWALL AND RECESSED HORIZONTAL SIDEWALL SPRINKLERS

MODEL GL4230 - K = 4.2 (59 metric) & MODEL GL5630 - K = 5.6 (80 metric)

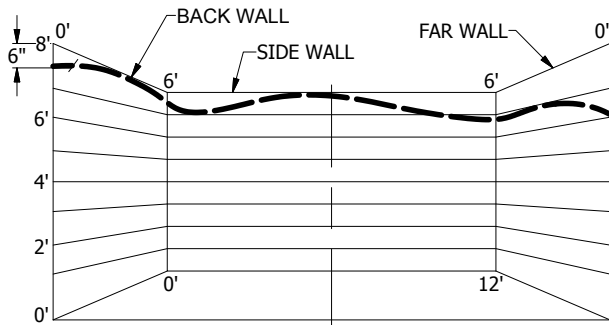

GL4230 - 19 GPM - 20.5 PSI
DEFLECTOR 6" BELOW CEILING

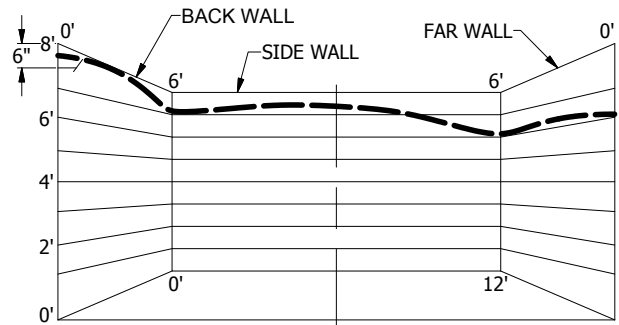

GL5630 - 20 GPM - 12.8 PSI
DEFLECTOR 6" BELOW CEILING

12' x 12' ROOM SIZE
(HALF PATTERN)

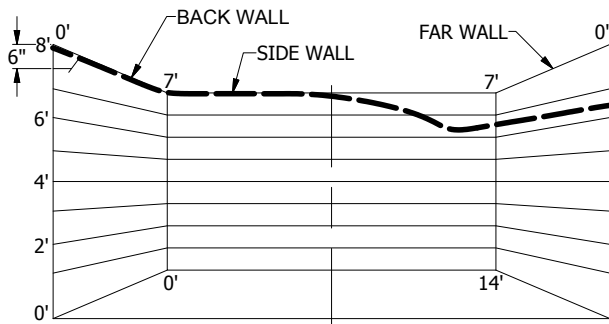

GL4230 - 21 GPM - 25.0 PSI
DEFLECTOR 6" BELOW CEILING

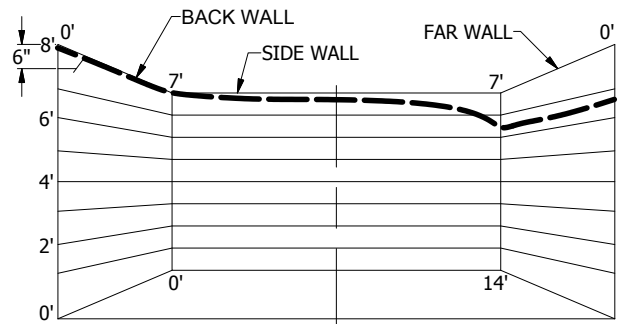

GL5630 - 23 GPM - 16.9 PSI
DEFLECTOR 6" BELOW CEILING

14' x 14' ROOM SIZE
(HALF PATTERN)

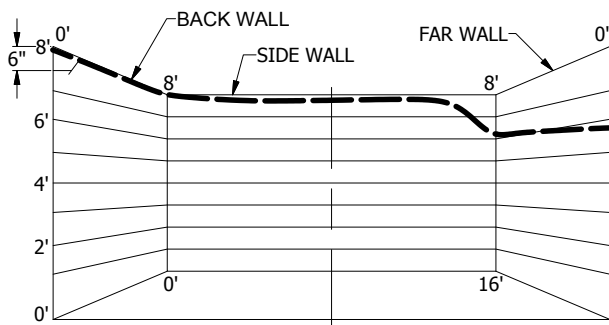

GL4230 - 24 GPM - 32.7 PSI
DEFLECTOR 6" BELOW CEILING

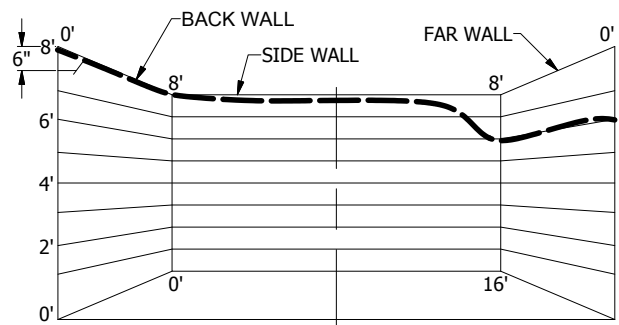

GL5630 - 24 GPM - 18.4 PSI
DEFLECTOR 6" BELOW CEILING

16' x 16' ROOM SIZE
(HALF PATTERN)

FLOW LEGEND

■■■■ TOP OF SPRINKLER FLOW

GLOBE WALL WETTING PATTERNS

MODEL GL5631 REPLACEMENT RESIDENTIAL HORIZONTAL SIDEWALL AND RECESSED HORIZONTAL SIDEWALL SPRINKLERS MODEL GL5631 - K = 5.6 (80 metric)

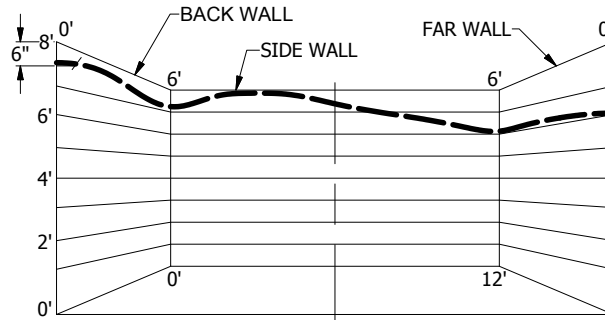

GL5631 - 18 GPM - 10.3 PSI
DEFLECTOR 6" BELOW CEILING
12' x 12' ROOM SIZE
(HALF PATTERN)

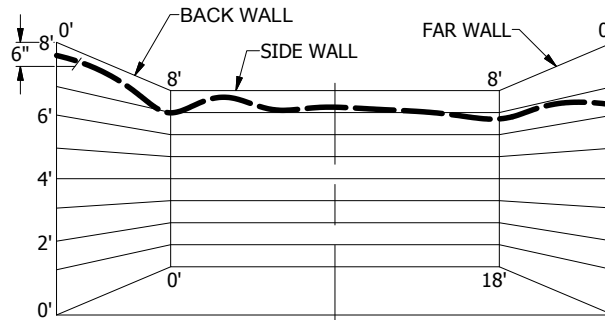

GL5631 - 30 GPM - 28.7 PSI
DEFLECTOR 6" BELOW CEILING
16' x 18' ROOM SIZE
(HALF PATTERN)

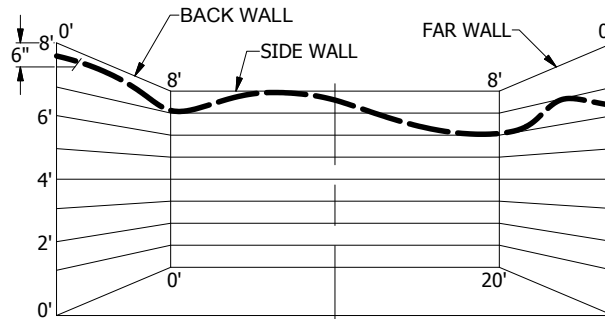

GL5631 - 35 GPM - 39.1 PSI
DEFLECTOR 6" BELOW CEILING
16' x 20' ROOM SIZE
(HALF PATTERN)

FLOW LEGEND

••••• TOP OF SPRINKLER FLOW

GLOBE WALL WETTING PATTERNS

THE FOLLOWING INSTALLATION GUIDELINES HAVE BEEN DEVELOPED USING IN-HOUSE DATA FOR THE CONVENIENCE OF CUSTOMERS CONFRONTED WITH INSTALLATIONS THAT ARE NOT REFERENCED IN THE NFPA 13 STANDARD.

GL SERIES RESIDENTIAL PENDENT AND RECESSED PENDENT SPRINKLERS ON A HORIZONTAL CEILING, DISTANCE TO PITCHED CEILING

MIN. ALLOWABLE A	ANGLE B DEGREES
0'-4"	5
0'-6"	10
0'-9"	15
1'-1"	20
1'-6"	25
1'-10"	30
2'-3"	35
2'-8"	40
3'-0"	45

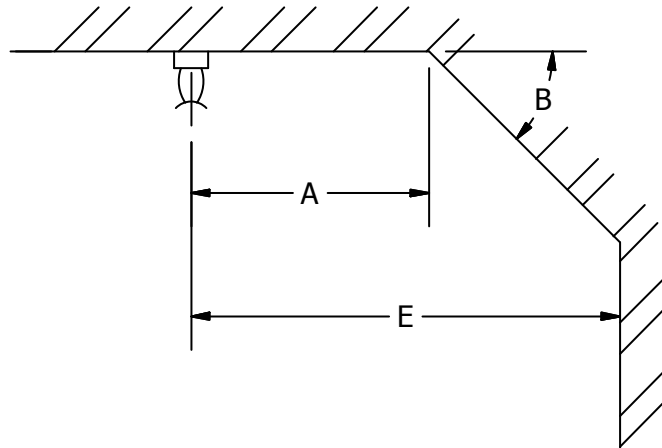

NOTE: E DIMENSION NOT TO EXCEED ONE HALF THE LISTED SPACING.

GL SERIES RESIDENTIAL PENDENT AND RECESSED PENDENT SPRINKLERS ON A PITCHED CEILING, DISTANCE TO HORIZONTAL CEILING

MIN. ALLOWABLE A	ANGLE B DEGREES
0'-8"	5
1'-0"	10
1'-4"	15
1'-8"	20
2'-2"	25
2'-5"	30
2'-8"	35
3'-3"	40
3'-6"	45

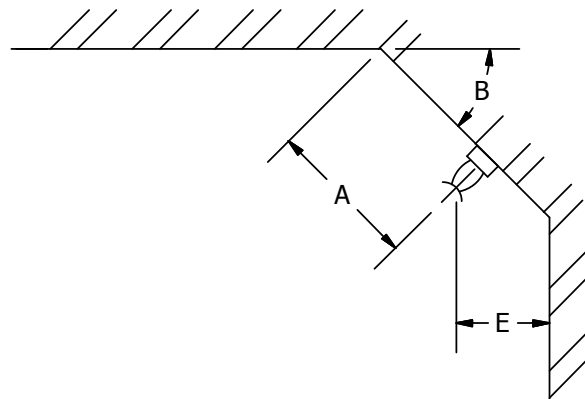

NOTE: E DIMENSION NOT TO EXCEED ONE HALF THE LISTED SPACING.

GLOBE INSTALLATION DIAGRAMS

GL SERIES RESIDENTIAL PENDENT AND RECESSED PENDENT SPRINKLERS MAXIMUM VERTICAL DISTANCE ON INTERSECTING HORIZONTAL AND PITCHED CEILINGS

MIN. ALLOWABLE A	MIN. ALLOWABLE B	ANGLE C DEGREES
0'-6"	8'-0"	5
1'-0"	8'-0"	10
1'-6"	8'-0"	15
2'-0"	8'-8"	20
2'-6"	9'-3"	25
3'-0"	10'-0"	30
3'-6"	10'-6"	35
4'-0"	11'-0"	40
4'-6"	11'-0"	45

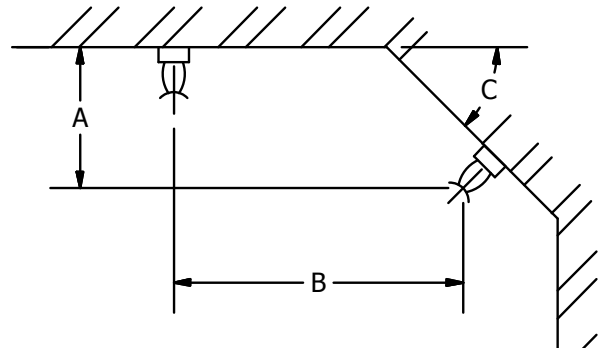

GL SERIES RESIDENTIAL PENDENT AND RECESSED PENDENT SPRINKLERS ON PITCHED CEILINGS OF MULTIPLE ANGLES

MIN. ALLOWABLE B	ANGLE C DEGREES
8'-0"	5
8'-0"	10
8'-0"	15
7'-6"	20
7'-0"	25
6'-6"	30
6'-0"	35
5'-6"	40
5'-0"	45

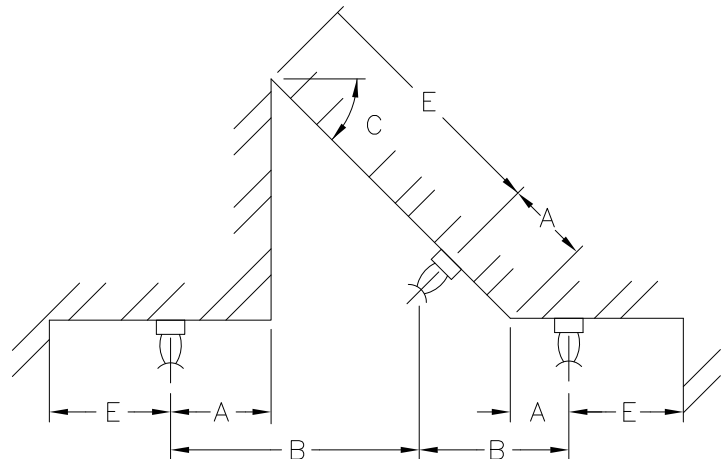

NOTES: A DIMENSION IS MINIMUM 6 INCHES.
E DIMENSION NOT TO EXCEED ONE HALF THE LISTED SPACING.

GLOBE INSTALLATION DIAGRAMS

GL SERIES RESIDENTIAL PENDENT AND RECESSED PENDENT SPRINKLERS ON OPPOSING PITCHED CEILINGS

MIN. ALLOWABLE A	ANGLE C DEGREES
8'-0"	5
8'-6"	10
10'-0"	15
11'-0"	20
11'-0"	25
12'-0"	30
12'-6"	35
12'-6"	40
13'-0"	45

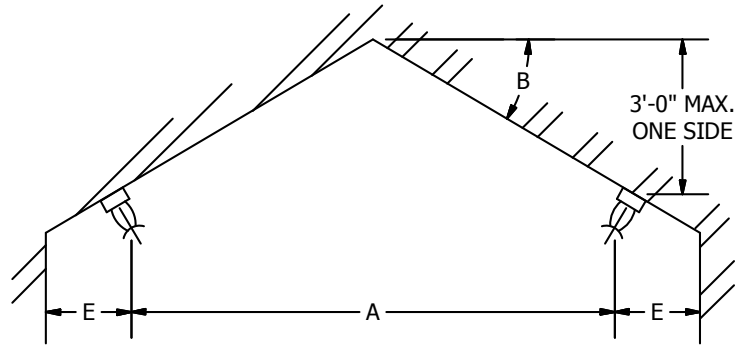

NOTES: E DIMENSION NOT TO EXCEED ONE HALF THE LISTED SPACING.

GL SERIES RESIDENTIAL PENDENT AND RECESSED PENDENT SINGLE SPRINKLER INSTALLATION ON OPPOSING PITCHED CEILINGS

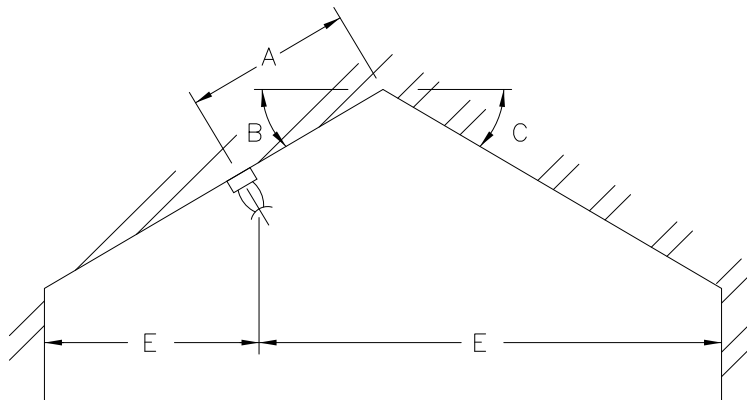

ANGLE * DEGREES	SPACING				
	12'	14'	16'	18'	20'
	A DIMENSION				
10	1'-0"	1'-0"	1'-0"	1'-0"	1'-0"
20	1'-0"	1'-0"	1'-0"	1'-6"	2'-0"
30	1'-0"	1'-0"	1'-6"	2'-0"	3'-0"
40	1'-0"	1'-6"	2'-6"	3'-0"	4'-0"
50	2'-0"	2'-6"	4'-0"	4'-6"	5'-0"
60	3'-0"	4'-0"	5'-0"	5'-6"	6'-0"

NOTES: E DIMENSION NOT TO EXCEED ONE HALF THE LISTED SPACING.

* ANGLE B OR C, WHICH EVER IS GREATER.

GLOBE INSTALLATION DIAGRAMS

GL SERIES RESIDENTIAL PENDENT AND RECESSED PENDENT SPRINKLERS ON OPPOSING PITCHED CEILINGS WITH MINIMUM REQUIRED OBSTRUCTION FOR WATER SHIELDING

A DIMENSION	MINIMUM ALLOWABLE B		
	ANGLE C 15°	ANGLE C 30°	ANGLE C 45°
1'-0"	0'-6"	0'-6"	0'-10"
2'-0"	0'-8"	1'-0"	1'-8"
3'-0"	0'-10"	1'-6"	2'-2"
4'-0"	1'-0"	2'-0"	2'-10"
5'-0"	1'-2"	2'-2"	3'-6"
6'-0"	N/A	2'-6"	3'-10"
7'-0"	N/A	N/A	3'-10"
8'-0"	N/A	N/A	4'-4"

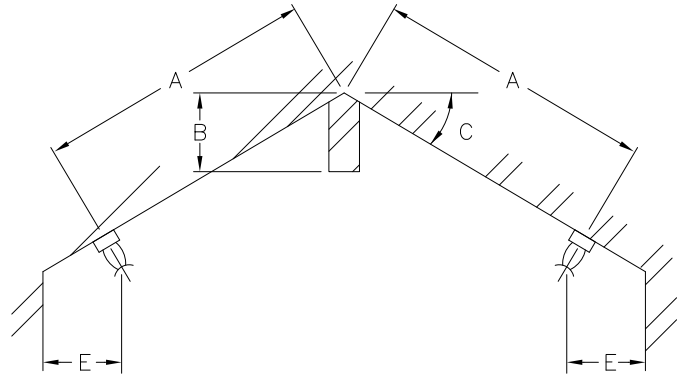

NOTE: E DIMENSION NOT TO EXCEED ONE HALF THE LISTED SPACING.

GL SERIES RESIDENTIAL PENDENT AND RECESSED PENDENT SPRINKLERS DISTANCE FROM OBSTRUCTIONS

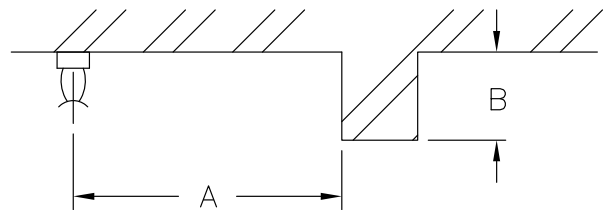
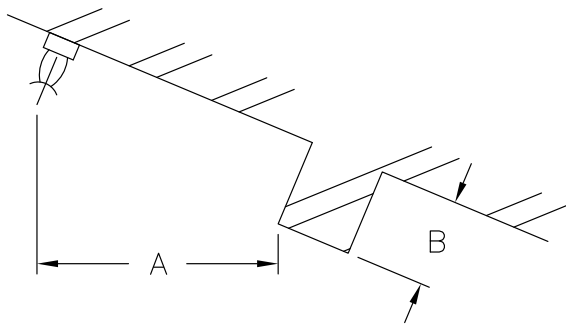

MIN. ALLOWABLE A	B DIMENSION
2'-4"	0'-4"
3'-4"	0'-6"
4'-0"	0'-8"
4'-4"	0'-10"
5'-0"	1'-0"
5'-8"	1'-2"
6'-4"	1'-4"

GLOBE INSTALLATION DIAGRAMS

GL SERIES RESIDENTIAL HORIZONTAL SIDEWALL AND RECESSED HORIZONTAL SIDEWALL SPRINKLERS DISTANCE FROM OBSTRUCTIONS

MIN. ALLOWABLE A	B DIMENSION
7'-4"	0'-4"
8'-4"	0'-6"
9'-5"	0'-8"
10'-6"	0'-10"
11'-3"	1'-0"
11'-8"	1'-2"
12'-4"	1'-4"

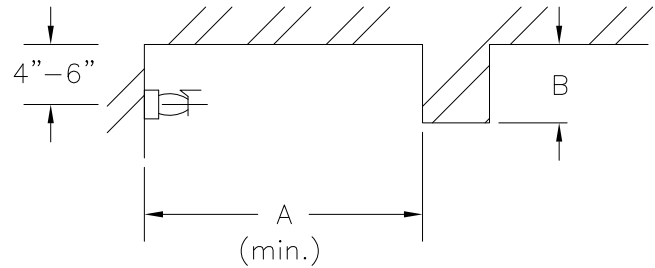

GL SERIES RESIDENTIAL HORIZONTAL SIDEWALL AND RECESSED HORIZONTAL SIDEWALL SPRINKLERS USED ON A PITCHED CEILING WITH DEFLECTOR PARALLEL TO CEILING

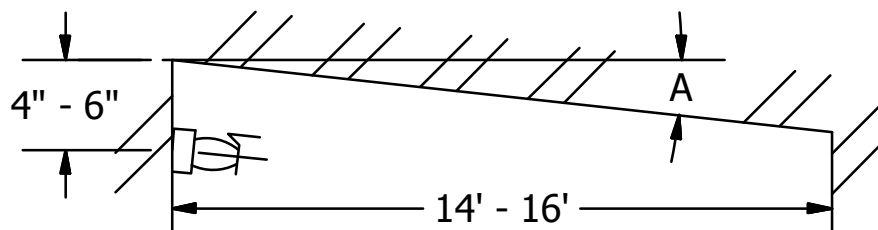

NOTE: ANGLE NOT TO EXCEED 30°.

GLOBE INSTALLATION DIAGRAMS

GL SERIES RESIDENTIAL HORIZONTAL SIDEWALL AND RECESSED HORIZONTAL SIDEWALL SPRINKLERS ON OPPOSING SLOPED CEILINGS

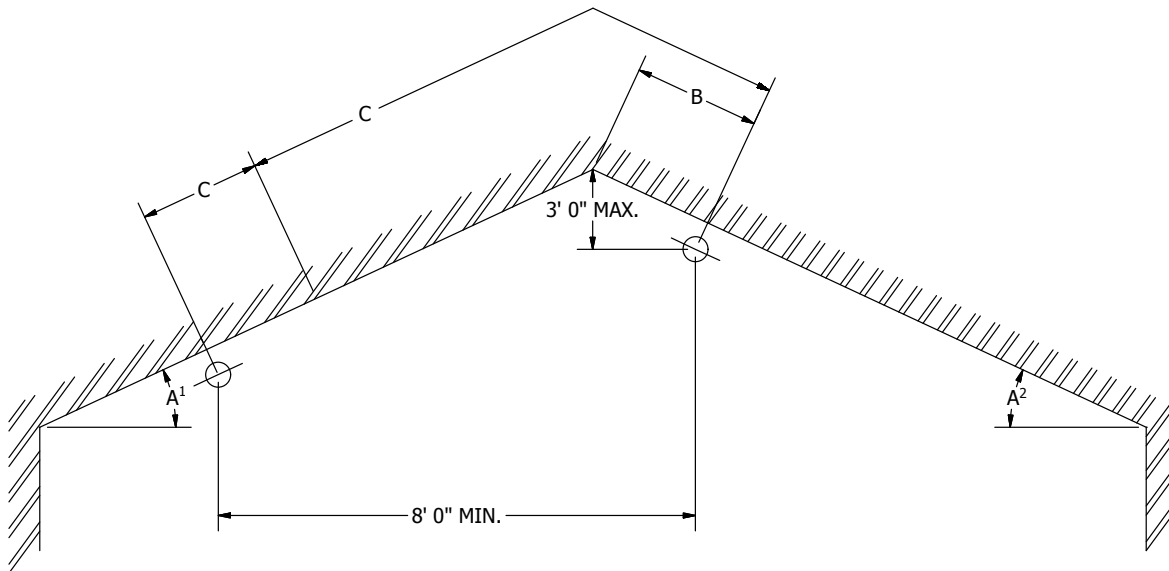

CEILING ANGLE A	SPRINKLER SPACING	MINIMUM SLOPED DISTANCE B	CEILING ANGLE A	SPRINKLER SPACING	MINIMUM SLOPED DISTANCE B
10°	12'	1'-0"	25°	12'	1'-0"
	14'	1'-0"		14'	1'-0"
	16'	1'-0"		16'	1'-0"
	18'	1'-0"		18'	2'-4"
	20'	1'-0"		20'	3'-10"
15°	12'	1'-0"	30°	12'	1'-4"
	14'	1'-0"		14'	1'-0"
	16'	1'-0"		16'	2'-0"
	18'	1'-0"		18'	3'-2"
	20'	2'-0"		20'	4'-4"
20°	12'	1'-0"	33.7°	12'	1'-0"
	14'	1'-0"		14'	1'-6"
	16'	1'-0"		16'	2'-8"
	18'	1'-0"		18'	3'-8"
	20'	3'-0"		20'	4'-8"

(A1), (A2) ACCEPTABLE FOR SLOPES 10° - 33.7°. USE THE GREATER ANGLE (A1), OR (A2).

(B) MINIMUM DISTANCE OF INTERSECTING OPPOSED SLOPED AS SPECIFIED IN THE ABOVE CHART.

(C) NOT TO EXCEED ONE HALF THE LISTED SPACING (SEE TECHNICAL DATA SHEETS A-4 & A-5) FOR COVERAGE AREA, MEASURED ALONG THE SLOPE.

NON-SYMMETRIC SPRINKLER LOCATIONS ON OPPOSING SLOPES.